

GeckoWiper®

User Manual



Document Title	GeckoWiper® User Manual
Revision	revM
Revision Date	20250501
Prepared By (Company)	Tigs Design & Engineering GmbH
Document Status	Released

Content

1. Introduction	3
2. Applicability	3
3. Package Content	4
4. Installation-Steps	5
5. Dismounting	8
6. Operation safety	11
7. USB-C Recharging:	11
8. Maintenance	12
9. Troubleshooting	12
10. Safety Precautions	14
11. Technical Specifications	14
12. Returns & Warranty	15
13. General Terms & Conditions	15
14. Impressum	16
15. Revision Track	16









1. Introduction





Congratulations on your purchase of **GeckoWiper®**, available via www.geckowiper.com, the state-of-the-art attachable Rear Windscreen Wiper with dual mounting via Vacuum Pad and Magnetic System! This patent pending, innovative product is designed to provide efficient and reliable cleaning for your car's rear window while being tool-free to mount. Please read this user manual carefully to ensure proper installation, maintenance, and usage.

2. Applicability

The rear window wiper system was successfully qualified for the following application

Table 1: List of approved GeckoWiper applications

Application @ Rear Window	Wiper Mounting Position	Remote Mounting Position	Qualification Status	Intro Video
Hyundai Ioniq 5 (2019-2024)	Bottom mounted 	Magnetic @speaker 	Qualified	 <i>Figure 1: QR code or LINK</i>
Kia EV6	Bottom mounted 	Hook & Loop (Velcro) 	Qualified	 <i>Figure 2: QR code or LINK</i>
Tesla Y	Top mounted, wind flag style 	Hook & Loop (Velcro) 	Beta-Testing Phase	 <i>Figure 3: QR code or LINK</i>

Polestar 2	<p>Top mounted, wind flag style</p> 	<p>Hook & Loop (Velcro)</p> 	Beta-Testing Phase	<p>Use video of Tesla Y</p>  <p>Figure 3: QR code or LINK</p>
Genesis GV60	<p>Top mounted, wind flag style</p> 	<p>Hook & Loop (Velcro)</p> 	Beta-Testing Phase	
Hyundai Ioniq 6	<p>Top mounted, wind flag style</p> 	<p>Magnetic @speaker</p>  	Beta-Testing Phase	

Attention:

- Use on vehicles and applications not listed in Table 1 is prohibited, as safety cannot be guaranteed due to the lack of application-specific qualification.
- For other applications, please check qualification regularly via www.geckowiper.com or give a direct request for your car/application via <https://www.geckowiper.com/compatibility>

3. Package Content

The GeckoWiper Rear Windscreen Wiper Unit comes as shown in Figure 1 with

- 1.) Geckowiper housing,
- 2.) Vacuum pump plunger indicator,
- 3.) Wiper arm,
- 4.) Wiper blade,
- 5.) Vacuum pad,
- 6.) Remote transmitter,
- 7.) Safety magnet

8.) USB-C charging port with waterproofing cover & LED charge indicator

9.) This current user manual, provided as QR-code link

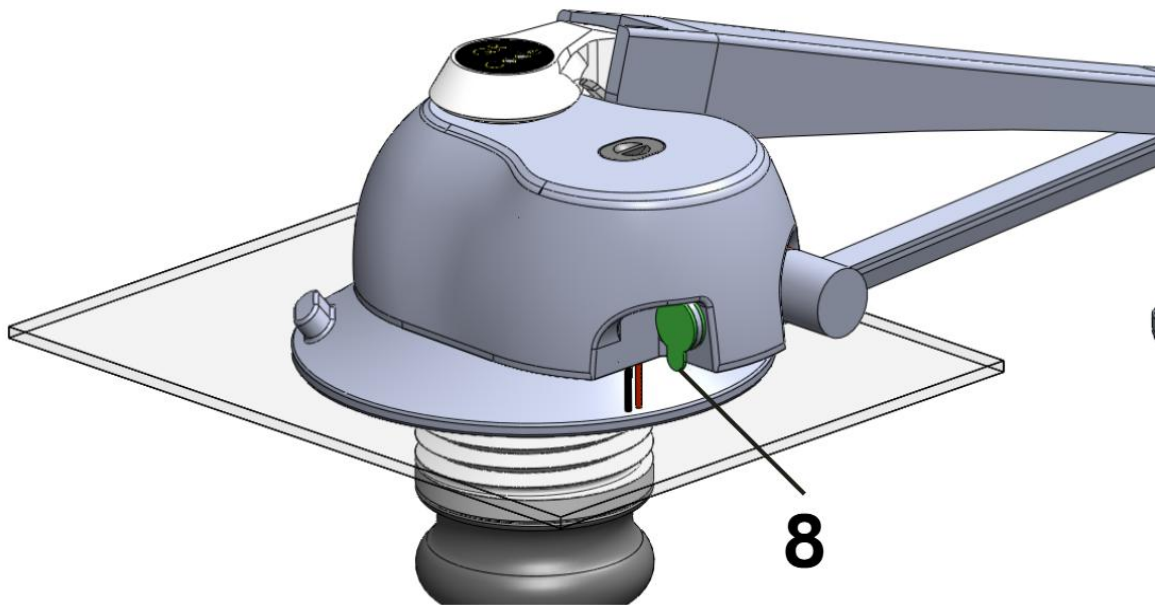
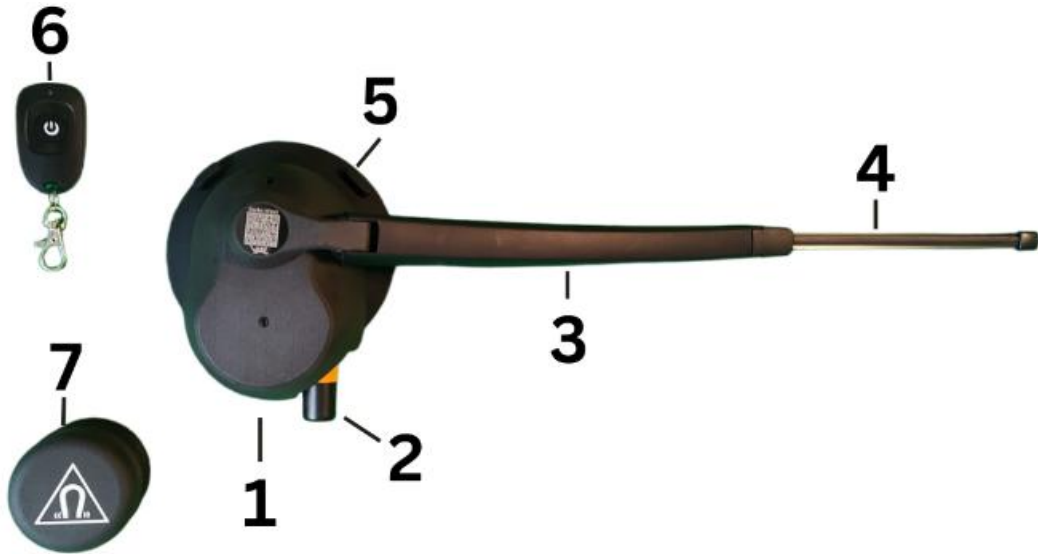













Figure 1: GeckoWiper key components, 1.) Geckowiper housing, 2.) Vacuum pump plunger indicator, 3.) Wiper arm, 4.) Wiper blade, 5.) Vacuum pad, 6.) Remote transmitter, 7.) Safety magnet, 8.) USB-C charging port with silicone waterproofing cover



4. Installation-Steps



The GeckoWiper installation is exemplary shown for Hyundai Ioniq 5 and shall be representative for all other qualified applications/cars of Table 1.

Step	Content	Details	Image
------	---------	---------	-------

1.	Watch Product Video	 <p>Figure 1: QR code or LINK</p>	 <p>Figure 2: Product video, QR code or LINK</p>
2.	Watch Mounting Video	 <p>Figure 3: QR code or LINK</p>	 <p>Figure 4: Watch mounting visualisation QR-code or LINK</p>
3.	Clean rear window wet	<p>Cleaning the Rear Glass Window: Wipe the rear glass window with a damp towel to remove any contaminants from the area where the vacuum pad will be placed.</p> <p>Attention: For optimal suction, ensure the glass window is made wet before applying the vacuum pad.</p>	 <p>Figure 5: Clean rear window area wet prior mounting the GeckoWiper®</p>  <p>Figure 5a: Lightly spray the window with water before mounting. GeckoWiper®</p>
4.	Clean suction pad & moisten with water	<p>Rinse the vacuum pad surface thoroughly with water to clean it. For installation, a wet vacuum pad surface provides better adhesion than a dry one.</p>	  <p>Figure 5b: Vacuum cleaning & wetting with water</p>





<p>5. Rear wiper installation</p>	<ul style="list-style-type: none"> • Position the wiper system as shown in the figure, pressing the housing firmly against the window. • Use the vacuum pump plunger to secure the system. • Ensure the vacuum pad is fully in contact with the glass and that the wiper blade has sufficient clearance from the top spoiler. • Pump the hand pump until the orange indicator disappears, indicating that a vacuum has been achieved. 	 <p><i>Figure 6: Position the rear wiper with the pump cylinder facing vertically downward and the wiper blade in an upright position. Press the housing firmly against the window, then use the vacuum pump until the orange indicator disappears, confirming a secure hold.</i></p>  <p><i>Figure 6b: If the vacuum level is insufficient, the orange vacuum pump plunger will become visible. Please check and re-secure as needed.</i></p>
<p>6. Check for any collision of blade motion with car body</p>	<p>Manually rotate the wiper arm $\pm 90^\circ$ from its vertical position to check for any collisions between the wiper blade and the vehicle spoiler.</p>	 <p><i>Figure 7: Check by hand motion $\pm 90^\circ$ against collision with spoiler</i></p>

7.	Mount counter magnet	<p>Magnet Handle Placement:</p> <ol style="list-style-type: none"> 1. Open the trunk and place the magnet handle on the rear window surface at a distance of more than 20 cm. 2. Slowly slide the magnet toward the center of the GeckoWiper® unit until it is attracted. <p>Attention: Never move the magnet directly behind the GeckoWiper® housing in an axial direction. Always slide it tangentially from a distance toward the housing to avoid strong axial pull, which could pose a shock risk to the window.</p>	 <p><i>Figure 8: Inner Magnet Placement:</i></p> <ol style="list-style-type: none"> 1. Open the trunk and place the inner magnet on the window, ensuring it is at least 20 cm away from the GeckoWiper® housing. 2. Slowly slide the magnet handle along the inner window toward the GeckoWiper® system. <p><i>This ensures dual safety through both vacuum and magnetic mounting.</i></p>  <p><i>Figure 9: The safety magnet is mounted on the backside (inside) of the car's rear window.</i></p>
8.	Mount remote key on loudspeaker	<p>The remote transmitter key features an internal magnet, enabling it to attach to the load speaker of the Hyundai Ioniq 5.</p> <p>For other vehicles (KIA EV6, TESLA Y,...) and applications, Velcro hook-and-loop tape is provided, preferable for remote attachment on hard plastic surfaces.</p>	 <p><i>Figure 10: Remote transmitter placement via internal magnet to any magnetic surface, exemplary on Hyundai Ioniq 5</i></p>

			 <p>Figure 4: Remote key fixation with Velcro on any hard plastic surface, exemplary Kia EV6 Cockpit</p>
9.	Start wipe motion	<p>To start wiping, press the remote transmitter key for more than 2 seconds. This delay is necessary due to the battery's deep-sleep design, which helps extend the wiper's internal battery life during standby.</p> <p>After two wiping cycles, the motion will stop, and the system will enter sleep mode again.</p> <p>Reactivation is possible after a brief delay of 1-3 seconds.</p>	 <p>Figure 11: Remote transmitter key press with RED light confirmation pressing by > 2sec for wipe activation</p>

5. Dismounting

Step	Content	Details	Image
10	Watch Product Video	 <p>Figure 12: QR code or LINK</p>	 <p>Figure 13: Product video, QR code or LINK</p>

11	Watch Dismount Video	 <p>Figure 14: QR code or LINK</p>	 <p>Figure 15: Dismounting visualisation video, QR or LINK</p>
12	Open trunk & Slide away safety magnet tangential to window	<p>Once the trunk is open, slide the internal safety magnet horizontally away from the housing.</p> <p>Attention: Do not attempt to pull the magnet away axially, as it is very strong. Always remove the magnet by sliding it away.</p>	 <p>Figure 16: Slide the trunk's internal safety magnet away sideways from the GeckoWiper® housing.</p>
13	Open vacuum	<p>Lift the vacuum pad's rubber handles to break the vacuum by vertically lifting one side of the pad.</p> <p>The GeckoWiper® unit can now be easily removed from the window.</p>	 <p>Figure 17: Open vacuum system by rubber handles pull-up motion</p>
14	Assemble Safety Magnet onto GeckoWiper for integrity	<p>The safety magnet is very strong and should be securely attached to the inner surface of the vacuum pad for storage. This minimizes external magnetic field attraction, ensuring safe storage.</p> <p>Attention: When placing the magnet on the vacuum pad, approach it with a rolling motion, not axially, to reduce the speed of attraction. Be</p>	 <p>Figure 18: For safe storage, attach the safety magnet to the inner surface of the vacuum pad.</p>

		cautious to avoid pinching your fingers.	
--	--	--	--

6. Operation safety

- a) Pressing the vacuum pump plunger creates a steady vacuum in the vacuum pad. The orange vacuum level indicator will disappear once the maximum vacuum is reached. Before use, ensure the orange vacuum indicator is NOT visible. If the GeckoWiper® remains mounted, check the indicator before driving to confirm it is not visible. If the vacuum pad was correctly attached, the orange indicator will remain fully absent during a 12 hour period, indicating a stable vacuum capable of lasting much longer (months).
- b) Only activate the wiping motion using the remote transmitter key when the system is securely attached to the rear window. Do not start the wiper while holding it in your hand!
- c) **ATTENTION:** Operate the GeckoWiper® only when both the vacuum and safety magnet are properly attached. **Using the vacuum pad alone, without the safety magnet, is prohibited.**
- d) For added safety, it is recommended to perform an initial test wipe with the remote key before starting any journey to confirm the GeckoWiper® is working properly.





7. USB-C Recharging:

The GeckoWiper® is equipped with a USB-C charging port, compatible with chargers without PD-tracker (refer to Table 3). When charging correctly, the blue LED indicator will light up once the USB-C charger is connected & will switch off after the battery is fully charged.

Attention:

Chargers with USBA on charger unit itself & cable from USBA to USBC typical work well with GeckoWiper, see also Table 3.

Table 3: List of working, compatible USBC chargers

Name	Apple 5W USB Power Adapter (OLD)	Apple 20W USB-C Power Adapter (NEW)	Android Chargers random, 5-30W	PC & Laptop internal USB ports	Any charger with USBA to USBC cable
USBC PD-Trigger ¹	No	Yes	No	Yes & No	No
Image					
Compatible ?	Yes	No	Yes	Case-by-case yes & no	Yes
Comment		Charger requires device feedback		Charger requires device feedback	

¹ Used by Apple to detect apple devices, but currently not compatible with GeckoWiper charging needs

If the GeckoWiper® system shows slowed wiping motions & stops working at all, it may need recharging. Use the built-in, waterproof USB-C charging port to recharge the device.

- Charging time is approximately 2-3 hours for a full charge.
- Connect the USB-C charging cable to a suitable power source, such as a car's internal USB charger, a phone charger, or a power bank (see Table 3).
- Using a power bank allows you to even charge the GeckoWiper® while it remains attached to the rear window.
- The blue LED light will remain steady while charging and will turn off once the battery is fully charged.







8. Maintenance

Before each drive, check

- 1. Vacuum Indicator:**
 - The orange pump vacuum indicator should **not** be visible, indicating the vacuum is available.
 - If the orange indicator is visible, the vacuum level has dropped, and repumping is needed or re-cleaning needed.
- 2. Window Cleaning:**
 - **Spray** the rear window with water to clean it before each new attachment.
- 3. Vacuum Pad Cleaning and Inspection:**
 - Ensure the vacuum pad is cleaned and free from damage before mounting.
- 4. Magnet Installation:**
 - Verify that the magnet behind the window is correctly installed and in good visual condition.
- 5. Magnet Handling:**
 - Always remove or attach the magnet using a **horizontal sliding motion**.
 - **Do not** move the magnet axially toward or away from the GeckoWiper® housing to avoid creating a shock on the rear window.

9. Troubleshooting

ID	Trouble	Possible reasons	Solution
1	Wiper does not start when remote transmitter key pressed	Key press <2sec	Press the key continuously for more than 2 seconds to activate the wiper. The system enters sleep mode to conserve energy, and the >2-second key press is required for reactivation.
2		GeckoWiper Battery empty	Recharge battery via USB-C port, see chapter 7
3		Remote Key Battery empty	 <p>Replace coin batteries, 2x CR2032 in remote key (typical after 2-years). Ensure to keep magnet on top of CR2032 battery</p>
4	Slow leakage of vacuum	Dry mounting surface of vacuum pad	Clean the window and pad with a damp towel to remove any particles. Reapply the pad to the pre-wetted rear window for optimal suction performance.
5		Damages on vacuum pad sealing surface	Replace vacuum pad, contact us
6		Debris in pump	Clean pump plunger
7		Dirty or uneven window surface	Clean the window and pad with a damp towel or rinse with water to remove any particles. Reapply the pad to the wet rear window for optimal suction performance.
8	Quick leakage of vacuum	Damaged vacuum pad surface	Replace vacuum pad, contact us
9		Damaged pump	Replace pump, contact us
10		Dirty or uneven window surface	Clean the window and pad with a damp towel or rinse with water to remove any particles. Reapply the pad to the wet rear window for optimal suction performance.
11	Stuck pump	Vacuum still available	Release the vacuum by pressing the two pad ears at the 10 o'clock and 2 o'clock positions. This will allow air to enter, causing the plunger to move outward.
12		Debris in pump	Clean pump internal parts
13	Wiper not at intended start position	Over time, wiper arm can move freely into other position	Press remote key >2sec, wiper arm will auto realign
14	Wiper blade worn	Long time usage or damage by ice/removal	Replacement wiper blade with suitable off-the-shelf blades of similar size

			 <table border="1" data-bbox="826 454 1391 779"> <thead> <tr> <th>Car</th> <th>Blade length [inch] / [cm]</th> <th>Source</th> </tr> </thead> <tbody> <tr> <td>Ioniq5, Tesla Y</td> <td>16" / 41</td> <td>Wiper Blade BOSCH 3 397 008 009</td> </tr> <tr> <td>Kia EV6</td> <td>13" / 33</td> <td>Wiper Blade BOSCH 3 397 008 006</td> </tr> </tbody> </table> 	Car	Blade length [inch] / [cm]	Source	Ioniq5, Tesla Y	16" / 41	Wiper Blade BOSCH 3 397 008 009	Kia EV6	13" / 33	Wiper Blade BOSCH 3 397 008 006
Car	Blade length [inch] / [cm]	Source										
Ioniq5, Tesla Y	16" / 41	Wiper Blade BOSCH 3 397 008 009										
Kia EV6	13" / 33	Wiper Blade BOSCH 3 397 008 006										
15	Wiper arm Spring fell off	Collision against hard body	 <p>Reinsert Wiper arm spring according following instruction video:</p>  <p>Video GeckoWiper Spring Remounting</p>									

			 <p>Above image: Insert of spring at bottom pin mandatory (bottom RED dot)</p>
16	USBC charging not possible, no BLUE LED on	Charger with PD Tracker (latest Iphone)	See chapter 7 for possible chargers

10. Safety Precautions

- a) **Do not operate the wiper** without sufficient vacuum, as indicated by the orange vacuum plunger indicator.
- b) **Keep the vacuum pad clean** to ensure optimal performance.
- c) **Always keep the safety magnet** mounted behind the window.
- d) **Use the product in compliance** with local traffic regulations.
- e) For best results, **remove the wiper unit** in car wash facilities and verify its attachment afterward.
- f) **Disassembling or opening the GeckoWiper® assembly** will void all warranty and return claims.

11. Technical Specifications

GeckoWiper®, an add-on removable rear window wiper

- Remote key activated >10m
- Battery powered
- Dual vacuum and magnet fixation
- Quick mount in 10sec
- Patent pending design
- Standby: 6-months+
- Compact Design
- Low Energy Design
- Tool-free mounting & dismount
- Wipe angle +-90deg
- USB-C charging, also possible while mounted on window
- Vacuum Indicator: Orange pump vacuum indicator
- Mass: 1kg

- Qualified car usage worldwide

12. Returns & Warranty

We want you to be totally psyched about the products you purchase at geckowiper.com. If at any time within 30 days of receiving your order, you're not satisfied, you may return the products to us for a refund.

- Any items damaged due to reasons not covered under warranty cannot be accepted back for refund under our Money-Back Guarantee.
- Associated return shipping fees are not refundable & have to be paid by customer
- This guarantee only applies to orders placed on geckowiper.com

For return & warranty, please use our [contact form](#).

13. General Terms & Conditions

I. Introduction

- These Terms govern all transactions between Tigs Design & Engineering GmbH ("Company") and the customer ("Customer") regarding the rear window wiper product ("GeckoWiper®"). By purchasing or using the Product, the Customer agrees to these Terms.

II. Scope

- These Terms apply to all sales and services. Any differing terms from the Customer are invalid unless accepted in writing by the Company.

III. Product Use and Liability

- The Product is intended solely for its designed purpose. The Company is not liable for damages from improper use, modifications, or incorrect installation. Installation & product maintenance must be performed according the assembly manual.

IV. International Use and Jurisdiction

- These Terms are governed by Swiss law, with disputes resolved in Zurich, Switzerland. The Customer is responsible for compliance with local laws and export regulations.

V. Warranty and Liability

- The Product is warranted against defects in materials and workmanship for a period of 2 years from the date of purchase. This warranty does not cover damage resulting from misuse, unauthorized modifications, improper installation, or normal wear and tear. The Company's liability under this warranty is strictly limited to the repair or replacement of the defective product, at the Company's sole discretion. The Company is not liable for any indirect, incidental, consequential, punitive damages or personal injury claims or death, including but not limited to loss of use, loss of profits, or any delays caused by circumstances beyond the Company's reasonable control (force majeure). Any claims under this warranty must be made in writing within the warranty period to GeckoWiper@gmail.com, and the Customer is responsible for all shipping and handling costs associated with warranty claims.

VI. Indemnification

- The Customer indemnifies the Company against claims arising from misuse of the Product, including third-party claims.

VII. Severability

- Invalid provisions do not affect the validity of remaining Terms.

VIII. Amendments

- The Company may amend these Terms at any time, effective upon notice.

IX. Brand affiliations

- GeckoWiper® is compatible with a wide variety of brands for car and other industries. However, we want to make it clear that GeckoWiper® is not made, endorsed, or affiliated with any of these brands. The names of these brands and their products are only used to inform you about the compatibility of our product, GeckoWiper®, with their devices.
- This compatibility information is provided solely for descriptive purposes and to help you understand how GeckoWiper® works with the devices you already own from other brands. While GeckoWiper® is compatible with several well-known devices and brands, it is an independent product developed and manufactured by our team.

X. Intellectual Property

- Trademarks: GeckoWiper® and any associated logos are trademarks of Tigs Design & Engineering GmbH. Unauthorized use is prohibited and may result in legal action.
- Patents: The product GeckoWiper® is currently in patent-pending status. Unauthorized reproduction, use, or sale of this invention is prohibited by law.

XI. Entire Agreement

- These Terms constitute the entire agreement between the parties, superseding prior agreements

Tigs Design & Engineering GmbH

Chaetzlerweg 2c

8311 Bruetten

Switzerland

01.May.2025

14. Impressum

Tigs Design & Engineering GmbH

Email contact: GeckoWiper@gmail.com

Website: www.GeckoWiper.com

15. Revision Track

Revision	Update	Date
RevG	Chapter 2: <ul style="list-style-type: none"> ● Tesla Y added Chapter 7: <ul style="list-style-type: none"> ● Added compatible USBC chargers & charge LED image added 	13.March 2025
RevH	Overall review	14.March 2025
RevK	Chapter 9: <ul style="list-style-type: none"> ● Added wiper arm spring fall out solution ● Added remote key replacement 	16.March 2025
RevL	Chapter 7	26.March 2025

	<ul style="list-style-type: none">● Update USBC chargers	
RevM	Chapter 2: <ul style="list-style-type: none">● Polestar 2 added● Genesis GV60 added● Hyundai Ioniq 6 added	1.Mai 2025